





PRODUCT SHEET  
REV 0.0 - IT202502  
**4010 FLAMINGO**



	CATALOG COLLECTION	TIKA LINE
	<b>DIMENSIONS (L x W x H) in cm</b>	270 x 380 x 325 cm
	<b>IMPACT AREA</b>	31,00 m <sup>2</sup>
	<b>MAXIMUM CFH</b>	160 cm
	<b>SUGGESTED AGE OF USE</b>	3+
	<b>NUMBER OF USERS</b>	10

SECURITY AREA

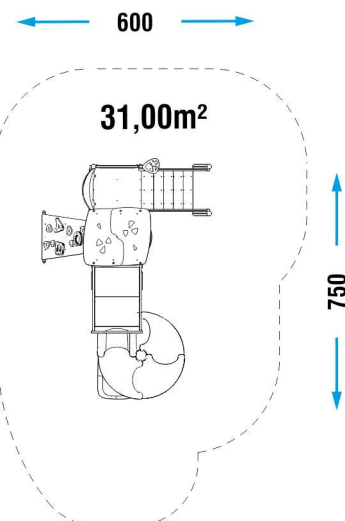

**COMPOSITION**

- n° 6 70 x70 mm octagonal section aluminium structural posts
- n° 2 recycled anti-slip HDPE decks
- n° 1 recycled HDPE sheet gable roof
- n° 3 open metal guard panels
- n° 2 roto-molded PTE guard panels
- n° 1 HDPE sheet decoration
- n° 1 stairs with recycled anti-slip HDPE steps
- n° 1 metal spiral balcony with anti-slip HDPE decks
- n° 1 roto-molded PTE spyral modular slide H160
- n° 1 recycled HDPE sheet ramp
- n° 1 recycled HDPE sheet climbing
- n° 1 metal ladder

**PLAY PANELS**

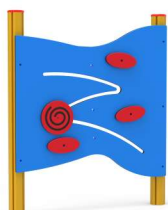
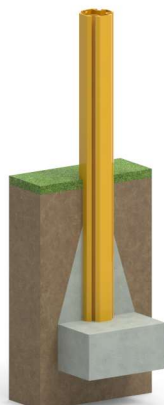
**LUDIC PLAY PANEL**  
**x1**

**LUDIC PLAY PANEL**  
**x1**
**INSTALLATION**

Where there is an aluminum pole, the plinth must be created directly on it.



If there is already an adequate fund in CLS the game can be supplied with special brackets for fixing to the ground (option applicable only with confirmation of feasibility).

Make a proper security surface according to CFH. Periodic maintenance is mandatory, following manual supplied to customer.

MATERIALE (mm) MATERIAL (mm)	DESCRIZIONE (mm) DESCRIPTION (mm)	PROFONDITÀ MINIMA (mm) (b) MINIMUM DEPTH (mm) (b)	ALTEZZA MASSIMA DI CADUTA (mm) CRITICAL FALL HEIGHT (mm)
PRATO/TERRICCIO LAWN/SOIL			1000 (d)
CORTECCIA BARK	PEZZATURA DA 20 A 80 20 TO 80 GRAIN SIZE	200	2000
		300	3000
TRUCIOLI DI LEGNO WOOD CHIPS	PEZZATURA DA 20 A 80 20 TO 80 GRAIN SIZE	200	2000
		300	3000
SABBIA SAND	PEZZATURA DA 20 A 80 20 TO 80 GRAIN SIZE	200	2000
		300	3000
GHIAIA GRAVEL	PEZZATURA DA 20 A 80 20 TO 80 GRAIN SIZE	200	2000
		300	3000
PAVIMENTAZIONE IN GOMMA RISPONDENTE A HIC RUBBER SURFACING RESPONDENT TO HIC	SPESSORE/THICKNESS	30mm	1000
		40mm	1300
		45mm	1500
		60mm	2000
		70mm	2500
		90mm	3000
			SOTTOPOSTA A PROVE DI CADUTA DEPENDENT ON CERTIFICATION TESTS