

## PRODUCT SHEET





## 0991 PIRAK

REV 0.0 - IT202509

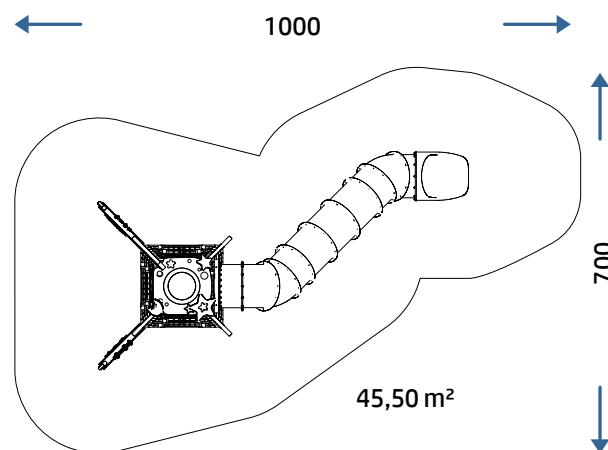

### SECURITY AREA



	CATALOG COLLECTION	TITAN COLLECTION
	<b>DIMENSIONS (L X W X H)</b>	390 x 660 x 540 cm
	<b>IMPACT AREA</b>	14,50 m <sup>2</sup>
	<b>MAXIMUM CFH</b>	150 cm
	<b>SUGGESTED AGE OF USE</b>	5+
	<b>NUMBER OF USERS</b>	20

## PRODUCT SHEET

## 0991 PIRAK

REV 0.0 - IT202509

### COMPOSITION

- n°4 70x130 profile structural aluminium poles
- n°2 octagonal section aluminum load-bearing poles
- n°2 antislip aluminium decks with powder coated steel frame
- n°1 powder coated steel ladder
- n°1 HDPE sheet climbing
- n°12 powder coated steel barriers
- n°1 rotating mold PTE tube slide
- n°1 19 mm thick HDPE roof
- HDPE sheet decorations

### PANNELLI GIOCO



LUDIC PLAY PANEL X1



LUDIC PLAY PANEL X1

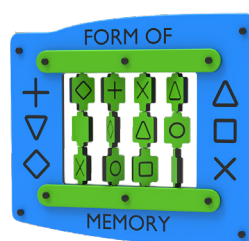

LUDIC PLAY PANEL X1

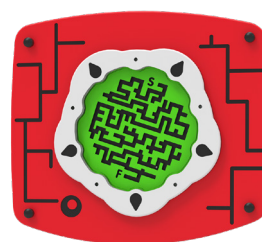

EDUCATIONAL PLAY PANEL X1

### INSTALLATION

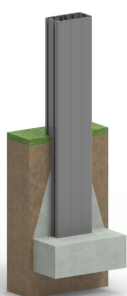

Where there is an aluminum pole, the plinth must be created directly on it.

Make a proper security surface according to CFH. Periodic maintenance is mandatory, following manual supplied to customer.

MATERIAL (mm)	DESCRIPTION (mm)	PROFONDITÀ MINIMA (mm) (b)	ALTEZZA MASSIMA DI CADUTA (mm)
LAWN/SOIL			1000 (d)
BARK	20 TO 80 GRAIN SIZE	200 300	2000 3000
WOOD CHIPS	20 TO 80 GRAIN SIZE	200 300	2000 3000
SAND	20 TO 80 GRAIN SIZE	200 300	2000 3000
GRAVEL	20 TO 80 GRAIN SIZE	200 300	2000 3000
RUBBER SURFACING RESPONDENT TO HIC	THICKNESS 30 MM		DEPENDENT ON CERTIFICATION TESTS 1000
	THICKNESS 40 MM		1300
	THICKNESS 45 MM		1500
	THICKNESS 60 MM		2000
	THICKNESS 70 MM		2500
	THICKNESS 90 MM		3000