







|   | CATALOG COLLECTION                  | PARTY LINE           |
|---|-------------------------------------|----------------------|
|  | <b>DIMENSIONS (L x W x H) in cm</b> | 755 x 505 x 470 cm   |
|   | <b>IMPACT AREA</b>                  | 58,50 m <sup>2</sup> |
|  | <b>MAXIMUM CFH</b>                  | 200 cm               |
|  | <b>SUGGESTED AGE OF USE</b>         | 5+                   |
|  | <b>NUMBER OF USERS</b>              | 12                   |

**SECURITY AREA**

850

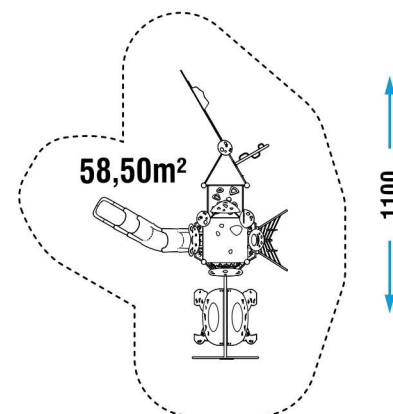

- COMPOSITION**
- n° 11 70x70 mm octagonal section aluminium structural posts
  - n° 2 recycled anti-slip HDPE decks
  - HDPE sheet decorations
  - n° 1 roto-molded PTE rotazionale guard panel
  - n° 2 HDPE sheet and metal guard panels
  - n° 1 metal climbing with handles
  - n° 1 metal thrust bearing
  - n° 1 roto-molded PTE modular slide (H190)
  - n° 1 «RAMPA» bridge
  - n° 1 HDPE sheet climbing with tube
  - n° 2 rope climbing
  - n° 2 HDPE sheet climbing
  - n° 1 HDPE sheet bench

**PLAY PANELS**

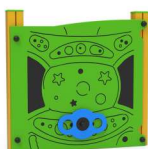

**LUDIC PLAY PANEL**  
x1

**INSTALLATION**

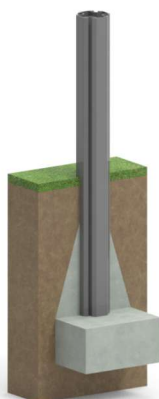

Where there is an aluminum pole, the plinth must be created directly on it.



If there is already an adequate fund in CLS the game can be supplied with special brackets for fixing to the ground (option applicable only with confirmation of feasibility).

*Make a proper security surface according to CFH. Periodic maintenance is mandatory, following manual supplied to customer.*

| MATERIALE (mm)<br>MATERIAL (mm)   | DESCRIZIONE (mm)<br>DESCRIPTION (mm)        | PROFONDITÀ MINIMA (mm) (b)<br>MINIMUM DEPTH (mm) (b) | ALTEZZA MASSIMA DI CADUTA (mm)<br>CRITICAL FALL HEIGHT (mm)      |
|---|---|--|--|
| PRATO/TERRICCIO<br>LAWN/SOIL  |   |  | 1000 (d)   |
| CORTECCIA<br>BARK   | PEZZATURA DA 20 A 80<br>20 TO 80 GRAIN SIZE | 200  | 2000   |
|   |   | 300  | 3000   |
| TRUCIOLI DI LEGNO<br>WOOD CHIPS   | PEZZATURA DA 20 A 80<br>20 TO 80 GRAIN SIZE | 200  | 2000   |
|   |   | 300  | 3000   |
| SABBIA<br>SAND  | PEZZATURA DA 20 A 80<br>20 TO 80 GRAIN SIZE | 200  | 2000   |
|   |   | 300  | 3000   |
| GHIAIA<br>GRAVEL  | PEZZATURA DA 20 A 80<br>20 TO 80 GRAIN SIZE | 200  | 2000   |
|   |   | 300  | 3000   |
| PAVIMENTAZIONE IN GOMMA<br>RISPONDENTE A HIC<br>RUBBER SURFACING<br>RESPONDENT TO HIC | SPESSORE/THICKNESS                          | 30mm   | 1000   |
|   |   | 40mm   | 1300   |
|   |   | 45mm   | 1500   |
|   |   | 60mm   | 2000   |
|   |   | 70mm   | 2500   |
|   |   | 90mm   | 3000   |
|   |   |  | SOTTOPOSTA A PROVE DI CADUTA<br>DEPENDENT ON CERTIFICATION TESTS |