

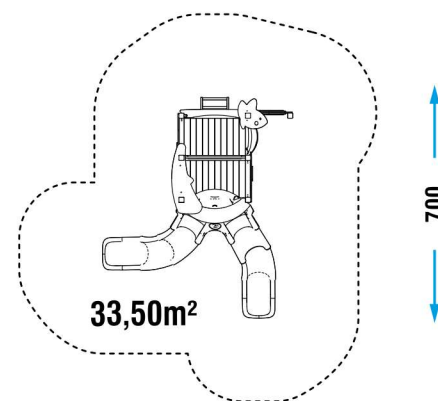





SECURITY AREA

650



| | CATALOG COLLECTION | PARTY LINE |
|-------------------------------------------------------------------------------------|-------------------------------------|----------------------|
|  | DIMENSIONS (L x W x H) in cm | 350 x 400 x 300 cm |
|  | IMPACT AREA | 33,50 m ² |
|  | MAXIMUM CFH | 125 cm |
|  | SUGGESTED AGE OF USE | 5+ |
|  | NUMBER OF USERS | 15 |

COMPOSITION

- n° 7 90x90 mm square section aluminum structural posts
 - n° 2 decks with powder-coated metal frame and aluminum slats
 - n° 1 HDPE sheet roof
 - n° 2 open metal guard panels
 - n° 1 roto-molded PTE open guard panel
 - n° 1 roto-molded PTE closed guard panel
 - n° 2 HDPE sheet guard panel
- n° 1 HDPE sheet climbing
 - n° 1 metal ladder
 - n° 1 roto-molded PTE double modular slide (H125)
 - n° 1 HDPE sheet decoration

PLAY PANELS

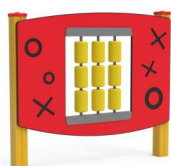
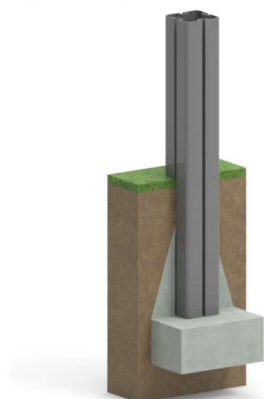
MUSICAL PLAY PANEL
x1

LUDIC PLAY PANEL
x1
INSTALLATION

Where there is an aluminum pole, the plinth must be created directly on it.



If there is already an adequate fund in CLS the game can be supplied with special brackets for fixing to the ground (option applicable only with confirmation of feasibility).

Make a proper security surface according to CFH. Periodic maintenance is mandatory, following manual supplied to customer.

| MATERIALE (mm) MATERIAL (mm) | DESCRIZIONE (mm) DESCRIPTION (mm) | PROFONDITÀ MINIMA (mm) (b) MINIMUM DEPTH (mm) (b) | ALTEZZA MASSIMA DI CADUTA (mm) CRITICAL FALL HEIGHT (mm) |
|---------------------------------------------------------------------------------------|---------------------------------------------|------------------------------------------------------|------------------------------------------------------------------|
| PRATO/TERRICCIO LAWN/SOIL | | | 1000 (d) |
| CORTECCIA BARK | PEZZATURA DA 20 A 80 20 TO 80 GRAIN SIZE | 200 | 2000 |
| | | 300 | 3000 |
| TRUCIOLI DI LEGNO WOOD CHIPS | PEZZATURA DA 20 A 80 20 TO 80 GRAIN SIZE | 200 | 2000 |
| | | 300 | 3000 |
| SABBIA SAND | PEZZATURA DA 20 A 80 20 TO 80 GRAIN SIZE | 200 | 2000 |
| | | 300 | 3000 |
| GHIAIA GRAVEL | PEZZATURA DA 20 A 80 20 TO 80 GRAIN SIZE | 200 | 2000 |
| | | 300 | 3000 |
| PAVIMENTAZIONE IN GOMMA RISPONDENTE A HIC RUBBER SURFACING RESPONDENT TO HIC | SPESSORE/THICKNESS | 30mm | 1000 |
| | | 40mm | 1300 |
| | | 45mm | 1500 |
| | | 60mm | 2000 |
| | | 70mm | 2500 |
| | | 90mm | 3000 |
| | | | SOTTOPOSTA A PROVE DI CADUTA DEPENDENT ON CERTIFICATION TESTS |