

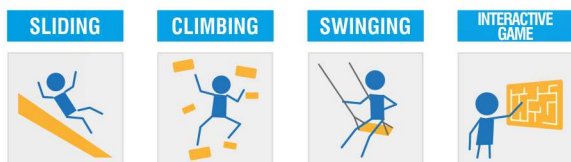





PRODUCT SHEET
REV 0.0 - IT202504
8005 LEONIDA



	CATALOG COLLECTION	PARTY LINE
	DIMENSIONS (L x W x H) in cm	640 x 320 x 285 cm
	IMPACT AREA	42,00 m ²
	MAXIMUM CFH	135 cm
	SUGGESTED AGE OF USE	3+
	NUMBER OF USERS	9

SECURITY AREA

750

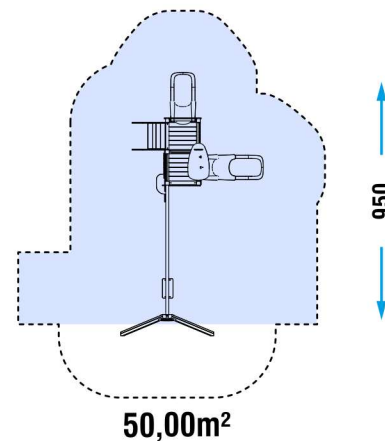

COMPOSITION

- n° 6 90x90 mm square section aluminum structural posts
- n° 2 decks with powder-coated metal frame and aluminum slats
- n° 1 HDPE sheet roof
- n° 1 ladder with HDPE sheet sides and recycled anti-slip HDPE sheet steps
- n° 1 open metal guard panel
- n° 2 HDPE sheet and metal guard panels
- n° 1 HDPE sheet climbing
- n° 2 HDPE sheet thrust bearings
- n° 1 roto-molded PTE modular slide (H60)
- n° 1 roto-molded PTE modular slide (H90)
- n° 1 swing
- n° 1 HDPE sheet bench

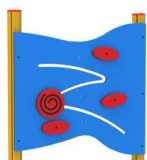
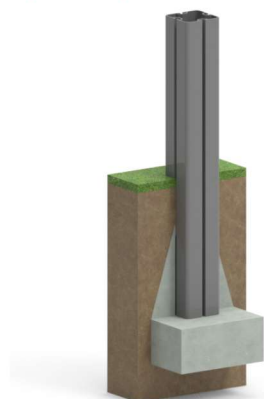
PLAY PANELS

LUDIC PLAY PANEL
x1
INSTALLATION

Where there is an aluminum pole, the plinth must be created directly on it.



If there is already an adequate fund in CLS the game can be supplied with special brackets for fixing to the ground (option applicable only with confirmation of feasibility).

Make a proper security surface according to CFH. Periodic maintenance is mandatory, following manual supplied to customer.

MATERIALE (mm) MATERIAL (mm)	DESCRIZIONE (mm) DESCRIPTION (mm)	PROFONDITÀ MINIMA (mm) (b) MINIMUM DEPTH (mm) (b)	ALTEZZA MASSIMA DI CADUTA (mm) CRITICAL FALL HEIGHT (mm)
PRATO/TERRICCIO LAWN/SOIL			1000 (d)
CORTECCIA BARK	PEZZATURA DA 20 A 80 20 TO 80 GRAIN SIZE	200	2000
		300	3000
TRUCIOLI DI LEGNO WOOD CHIPS	PEZZATURA DA 20 A 80 20 TO 80 GRAIN SIZE	200	2000
		300	3000
SABBIA SAND	PEZZATURA DA 20 A 80 20 TO 80 GRAIN SIZE	200	2000
		300	3000
GHIAIA GRAVEL	PEZZATURA DA 20 A 80 20 TO 80 GRAIN SIZE	200	2000
		300	3000
PAVIMENTAZIONE IN GOMMA RISPONDENTE A HIC RUBBER SURFACING RESPONDENT TO HIC	SPESSORE/THICKNESS	30mm	1000
		40mm	1300
		45mm	1500
		60mm	2000
		70mm	2500
		90mm	3000
			SOTTOPOSTA A PROVE DI CADUTA DEPENDENT ON CERTIFICATION TESTS