





PRODUCT SHEET
REV 0.0 - IT202504
8004 KIHON



ORGANIZATION WITH QUALITY MANAGEMENT SYSTEM
ISO 9001:2015 CERTIFIED by
EuCI European Certification Institute LTD
Certificate N.: GOTT2532Q1902

ORGANIZATION WITH ENVIRONMENTAL MANAGEMENT SYSTEM
ISO 14001:2015 CERTIFIED by
EuCI European Certification Institute LTD
Certificate No: GOTT2532E1801



	CATALOG COLLECTION	PARTY LINE
	DIMENSIONS (L x W x H) in cm	375 x 215 x 280 cm
	IMPACT AREA	26,50 m ²
	MAXIMUM CFH	100 cm
	SUGGESTED AGE OF USE	5+
	NUMBER OF USERS	8

SECURITY AREA

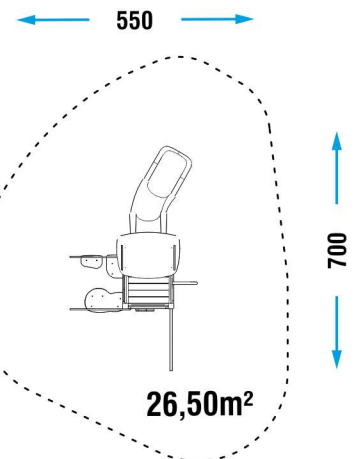

COMPOSITION

- n° 6 90x90 mm square section aluminum structural posts
 - n° 2 90x90 mm square section aluminum structural posts
 - n° 1 HDPE sheet roof
 - n° 1 open metal guard panel
 - n° 1 open metal guard panel for perch
 - n° 1 fireman's post
 - n° 1 HDPE sheet and metal guard panel
 - n° 2 HDPE sheet guard panels
- n° 1 HDPE sheet climbing
 - n° 1 metal and HDPE sheet climbing
 - n° 1 metal thrust bearing
 - n° 1 roto-molded PTE modular slide (H100)
 - n° 1 HDPE sheet table
 - n° 2 HDPE sheet benches

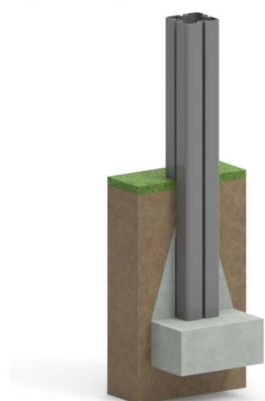
PLAY PANELS
INSTALLATION

Where there is an aluminum pole, the plinth must be created directly on it.



If there is already an adequate fund in CLS the game can be supplied with special brackets for fixing to the ground (option applicable only with confirmation of feasibility).

Make a proper security surface according to CFH. Periodic maintenance is mandatory, following manual supplied to customer.

MATERIALE (mm) MATERIAL (mm)	DESCRIZIONE (mm) DESCRIPTION (mm)	PROFONDITÀ MINIMA (mm) (b) MINIMUM DEPTH (mm) (b)	ALTEZZA MASSIMA DI CADUTA (mm) CRITICAL FALL HEIGHT (mm)
PRATO/TERRICCIO LAWN/SOIL			1000 (d)
CORTECCIA BARK	PEZZATURA DA 20 A 80 20 TO 80 GRAIN SIZE	200	2000
		300	3000
TRUCIOLI DI LEGNO WOOD CHIPS	PEZZATURA DA 20 A 80 20 TO 80 GRAIN SIZE	200	2000
		300	3000
SABBIA SAND	PEZZATURA DA 20 A 80 20 TO 80 GRAIN SIZE	200	2000
		300	3000
GHIAIA GRAVEL	PEZZATURA DA 20 A 80 20 TO 80 GRAIN SIZE	200	2000
		300	3000
PAVIMENTAZIONE IN GOMMA RISPONDENTE A HIC RUBBER SURFACING RESPONDENT TO HIC	SPESSORE/THICKNESS	30mm	1000
		40mm	1300
		45mm	1500
		60mm	2000
		70mm	2500
		90mm	3000
			SOTTOPOSTA A PROVE DI CADUTA DEPENDENT ON CERTIFICATION TESTS