





	CATALOG COLLECTION	ESA LINE
	DIMENSIONS (L x W x H) in cm	740 x 510 x 400 cm
	IMPACT AREA	59,00 m ²
	MAXIMUM CFH	115 cm
	SUGGESTED AGE OF USE	3+
	NUMBER OF USERS	25



- COMPOSITION**
- n° 13 Ø120 mm hexagonal section aluminum posts
 - n° 6 powder-coated chequered aluminum decks
 - n° 1 open metal guard panel
 - n° 1 open metal guard panel for perch
 - n° 1 fireman's post
 - n° 6 closed HDPE sheet guard panels
 - n° 1 HDPE sheet climbing
 - n° 1 rope climbing
 - n° 1 roto-molded PTE tube modular slide (H115)
 - HDPE sheet decorations

PLAY PANELS

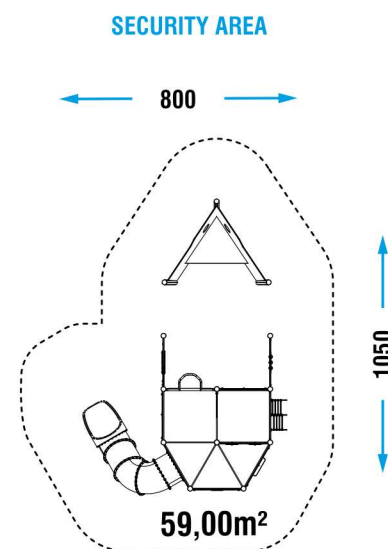
LUDIC PLAY PANEL
x1

LUDIC PLAY PANEL
x1

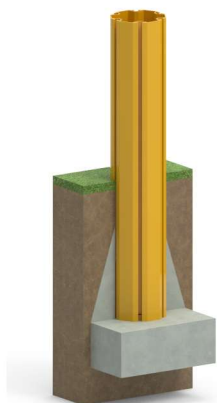
MUSICAL PLAY PANEL
x1
INSTALLATION

Where there is an aluminum pole, the plinth must be created directly on it.



If there is already an adequate fund in CLS the game can be supplied with special brackets for fixing to the ground (option applicable only with confirmation of feasibility).

Make a proper security surface according to CFH. Periodic maintenance is mandatory, following manual supplied to customer.

MATERIALE (mm) MATERIAL (mm)	DESCRIZIONE (mm) DESCRIPTION (mm)	PROFONDITÀ MINIMA (mm) (b) MINIMUM DEPTH (mm) (b)	ALTEZZA MASSIMA DI CADUTA (mm) CRITICAL FALL HEIGHT (mm)
PRATO/TERRICCIO LAWN/SOIL			1000 (d)
CORTECCIA BARK	PEZZATURA DA 20 A 80 20 TO 80 GRAIN SIZE	200	2000
		300	3000
TRUCIOLI DI LEGNO WOOD CHIPS	PEZZATURA DA 20 A 80 20 TO 80 GRAIN SIZE	200	2000
		300	3000
SABBIA SAND	PEZZATURA DA 20 A 80 20 TO 80 GRAIN SIZE	200	2000
		300	3000
GHIAIA GRAVEL	PEZZATURA DA 20 A 80 20 TO 80 GRAIN SIZE	200	2000
		300	3000
PAVIMENTAZIONE IN GOMMA RISPONDENTE A HIC RUBBER SURFACING RESPONDENT TO HIC	SPESSORE/THICKNESS	30mm	1000
		40mm	1300
		45mm	1500
		60mm	2000
		70mm	2500
		90mm	3000
			SOTTOPOSTA A PROVE DI CADUTA DEPENDENT ON CERTIFICATION TESTS