





## PRODUCT SHEET

## 6750 BALINOR

REV 0.0 - IT202509



### SECURITY AREA

	CATALOG COLLECTION	PARTY LINE
	<b>DIMENSIONS (L X W X H)</b>	1230 x 340 x 570 cm
	<b>IMPACT AREA</b>	69,00 m <sup>2</sup>
	<b>MAXIMUM CFH</b>	125 cm (270 cm)
	<b>SUGGESTED AGE OF USE</b>	5+
	<b>NUMBER OF USERS</b>	25

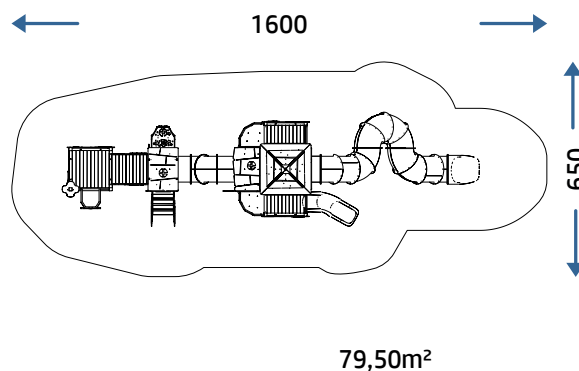

# PRODUCT SHEET

# 6750 BALINOR

REV 0.0 - IT202509

## COMPOSITION

- n° 22 90x90 mm square section aluminum structural posts
- n° 9 decks with powder-coated metal frame and aluminum slats
- n° 1 HDPE sheet stairs with recycled non-slip HDPE steps
- n° 7 HDPE sheet guard panels
- n° 1 open metal guard panel
- n° 1 «ZIG-ZAG» perch
- n° 2 round balconies
- n° 1 steel ladder with protective metal locks and HDPE sheet
- n° 1 «CORDE» bridge
- n° 1 «RAMPA» bridge
- n° 1 rotational PTE four-pitched roof
- n° 2 HDPE sheet roofs
- n° 3 HDPE sheet climbings
- n° 1 rope climbing and PTE rungs
- n° 1 2-rung backrest
- n° 1 HDPE sheet thrust bearing
- n° 1 roto-molded PTE modular tunnel
- n° 1 roto-molded PTE modular slide (H110)
- n° 1 roto-molded PTE tube modular slide (H300)
- n° 1 table with throne

## PLAY PANELS

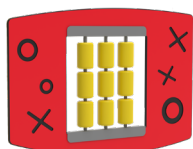

LUDIC PLAY  
PANEL X2

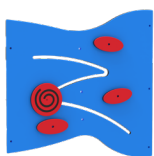

LUDIC PLAY  
PANEL X1

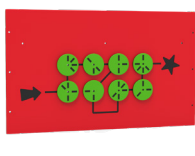

EDUCATIONAL PLAY  
PANEL X1



MUSICAL PLAY  
PANEL X1

## INSTALLATION

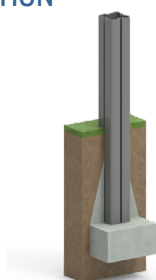

Where there is an aluminum pole, the plinth must be created directly on it.

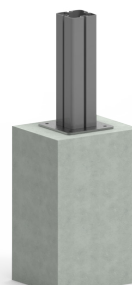

If there is already an adequate fund in CLS the game can be supplied with special brackets for fixing to the ground (option applicable only with confirmation of feasibility).

Make a proper security surface according to CFH. Periodic maintenance is mandatory, following manual supplied to customer.

MATERIAL (mm)	DESCRIPTION (mm)	MINIMUM DEPTH (mm) (b)	CRITICAL FALL HEIGHT (mm)
LAWN/SOIL			1000 (d)
BARK	20 TO 80 GRAIN SIZE	200 300	2000 3000
WOOD CHIPS	20 TO 80 GRAIN SIZE	200 300	2000 3000
SAND	20 TO 80 GRAIN SIZE	200 300	2000 3000
GRAVEL	20 TO 80 GRAIN SIZE	200 300	2000 3000
RUBBER SURFACING RESPONDENT TO HIC	THICKNESS 30 MM		DEPENDENT ON CERTIFICATION TESTS 1000
	THICKNESS 40 MM		1300
	THICKNESS 45 MM		1500
	THICKNESS 60 MM		2000
	THICKNESS 70 MM		2500
	THICKNESS 90 MM		3000