





	CATALOG COLLECTION	PARTY LINE
	DIMENSIONS (L x W x H) in cm	200 x 310 x 330 cm
	IMPACT AREA	24,50 m ²
	MAXIMUM CFH	95 cm
	SUGGESTED AGE OF USE	3+
	NUMBER OF USERS	12

SECURITY AREA

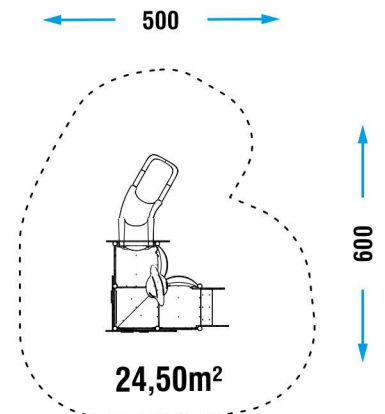

- COMPOSITION**
- n° 8 70x70 mm octagonal section aluminium structural posts
 - n° 4 recycled anti-slip HDPE decks
 - n° 1 open metal guard panel
 - n° 2 roto-molded PTE guard panels
 - n° 3 HDPE sheet guard panels
 - n° 3 HDPE sheet climbings
 - n° 1 HDPE sheet ladder and anti-slip HDPE sheet steps
 - n° 1 HDPE sheet thrust bearing
 - n° 1 roto-molded PTE modular slides (H95)
 - HDPE sheet decorations

PLAY PANELS



LUDIC PLAY PANEL
x1



LUDIC PLAY PANEL
x1



LUDIC PLAY PANEL
x1

INSTALLATION

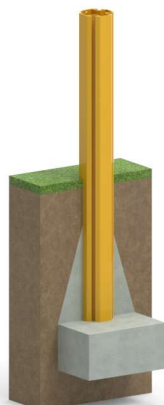

Where there is an aluminum pole, the plinth must be created directly on it.



If there is already an adequate fund in CLS the game can be supplied with special brackets for fixing to the ground (option applicable only with confirmation of feasibility).

Make a proper security surface according to CFH. Periodic maintenance is mandatory, following manual supplied to customer.

MATERIALE (mm) MATERIAL (mm)	DESCRIZIONE (mm) DESCRIPTION (mm)	PROFONDITÀ MINIMA (mm) (b) MINIMUM DEPTH (mm) (b)	ALTEZZA MASSIMA DI CADUTA (mm) CRITICAL FALL HEIGHT (mm)
PRATO/TERRICCIO LAWN/SOIL			1000 (d)
CORTECCIA BARK	PEZZATURA DA 20 A 80 20 TO 80 GRAIN SIZE	200	2000
		300	3000
TRUCIOLI DI LEGNO WOOD CHIPS	PEZZATURA DA 20 A 80 20 TO 80 GRAIN SIZE	200	2000
		300	3000
SABBIA SAND	PEZZATURA DA 20 A 80 20 TO 80 GRAIN SIZE	200	2000
		300	3000
GHIAIA GRAVEL	PEZZATURA DA 20 A 80 20 TO 80 GRAIN SIZE	200	2000
		300	3000
PAVIMENTAZIONE IN GOMMA RISPONDENTE A HIC RUBBER SURFACING RESPONDENT TO HIC	SPESSORE/THICKNESS	30mm	1000
		40mm	1300
		45mm	1500
		60mm	2000
		70mm	2500
		90mm	3000
			SOTTOPOSTA A PROVE DI CADUTA DEPENDENT ON CERTIFICATION TESTS