







| | CATALOG COLLECTION | FUN COLLECTION |
|---|-------------------------------------|----------------------|
|  | DIMENSIONS (L x W x H) in cm | 340 x 330 x 290 cm |
|  | IMPACT AREA | 31,00 m ² |
|  | MAXIMUM CFH | 85 cm |
|  | SUGGESTED AGE OF USE | 3+ |
|  | NUMBER OF USERS | 12 |

SECURITY AREA

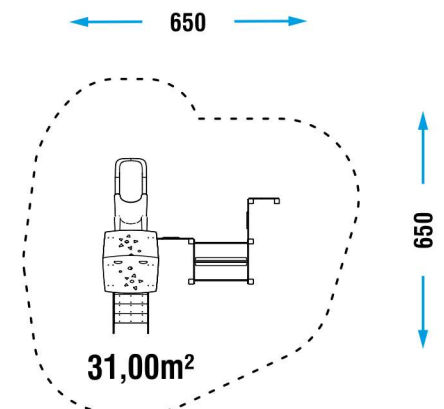

- COMPOSITION**
- n° 10 90x90 mm square section aluminum structural posts
 - n° 1 deck with powder-coated metal frame and aluminium slats
 - n° 1 roto-molded PTE modular slide (H85)
 - n° 1 HDPE sheet roof and roto-molded PTE supports
 - n° 1 metal thrust bearing
 - n° 2 HDPE sheet and metal guard panels
 - n° 1 stairs with anti-slip recycled HDPE steps
 - n° 1 tunnel in PTE rotazionale

PLAY PANELS

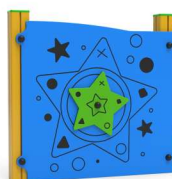
LUDIC PLAY PANEL
x1

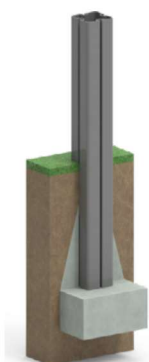
LUDIC PLAY PANEL
x1

EDUCATIONAL PLAY PANEL
x1
INSTALLATION

Where there is an aluminum pole, the plinth must be created directly on it.



If there is already an adequate fund in CLS the game can be supplied with special brackets for fixing to the ground (option applicable only with confirmation of feasibility).

Make a proper security surface according to CFH. Periodic maintenance is mandatory, following manual supplied to customer.

| MATERIALE (mm) MATERIAL (mm) | DESCRIZIONE (mm) DESCRIPTION (mm) | PROFONDITÀ MINIMA (mm) (b) MINIMUM DEPTH (mm) (b) | ALTEZZA MASSIMA DI CADUTA (mm) CRITICAL FALL HEIGHT (mm) |
|---|---|--|---|
| PRATO/TERRICCIO LAWN/SOIL | | | 1000 (d) |
| CORTECCIA BARK | PEZZATURA DA 20 A 80 20 TO 80 GRAIN SIZE | 200 | 2000 |
| | | 300 | 3000 |
| TRUCIOLI DI LEGNO WOOD CHIPS | PEZZATURA DA 20 A 80 20 TO 80 GRAIN SIZE | 200 | 2000 |
| | | 300 | 3000 |
| SABBIA SAND | PEZZATURA DA 20 A 80 20 TO 80 GRAIN SIZE | 200 | 2000 |
| | | 300 | 3000 |
| GHIAIA GRAVEL | PEZZATURA DA 20 A 80 20 TO 80 GRAIN SIZE | 200 | 2000 |
| | | 300 | 3000 |
| PAVIMENTAZIONE IN GOMMA RISPONDENTE A HIC RUBBER SURFACING RESPONDENT TO HIC | SPESSORE/THICKNESS | 30mm | 1000 |
| | | 40mm | 1300 |
| | | 45mm | 1500 |
| | | 60mm | 2000 |
| | | 70mm | 2500 |
| | | 90mm | 3000 |