







	CATALOG COLLECTION	PARTY LINE
	DIMENSIONS (L x W x H) in cm	370 x 230 x 275 cm
	IMPACT AREA	26,00 m ²
	MAXIMUM CFH	100 cm
	SUGGESTED AGE OF USE	5+
	NUMBER OF USERS	10

SECURITY AREA

← 550 →

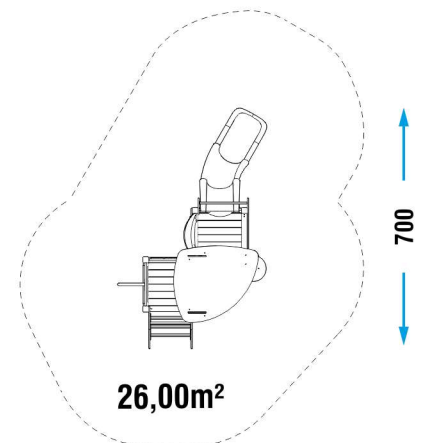

COMPOSITION

- n° 7 90x90 mm square section aluminium structural posts
- n° 2 decks with powder-coated metal frame and aluminum slats
- n° 1 round balcony
- n° 1 HDPE sheet roof
- n° 1 metal and HDPE sheet guard panel
- n° 1 roto-molded PTE guard panel
- n° 1 HDPE sheet guard panel
- n° 1 open metal guard panel for perch
- n° 1 metal and HDPE sheet backrest
- n° 1 fireman's post
- n° 1 roto-molded PTE modular slide (H100)
- n° 1 HDPE sheet bench

PLAY PANELS

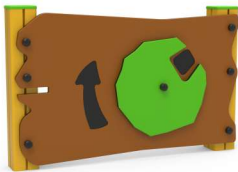

LUDIC PLAY PANEL
x1

INSTALLATION

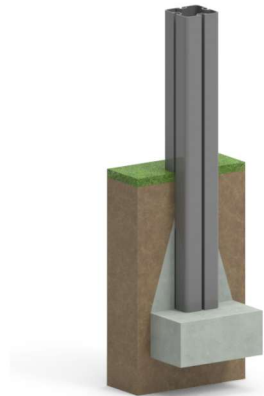

Where there is an aluminum pole, the plinth must be created directly on it.



If there is already an adequate fund in CLS the game can be supplied with special brackets for fixing to the ground (option applicable only with confirmation of feasibility).

Make a proper security surface according to CFH. Periodic maintenance is mandatory, following manual supplied to customer.

MATERIALE (mm) MATERIAL (mm)	DESCRIZIONE (mm) DESCRIPTION (mm)	PROFONDITÀ MINIMA (mm) (b) MINIMUM DEPTH (mm) (b)	ALTEZZA MASSIMA DI CADUTA (mm) CRITICAL FALL HEIGHT (mm)
PRATO/TERRICCIO LAWN/SOIL			1000 (d)
CORTECCIA BARK	PEZZATURA DA 20 A 80 20 TO 80 GRAIN SIZE	200 300	2000 3000
TRUCIOLI DI LEGNO WOOD CHIPS	PEZZATURA DA 20 A 80 20 TO 80 GRAIN SIZE	200 300	2000 3000
SABBIA SAND	PEZZATURA DA 20 A 80 20 TO 80 GRAIN SIZE	200 300	2000 3000
GHIAIA GRAVEL	PEZZATURA DA 20 A 80 20 TO 80 GRAIN SIZE	200 300	2000 3000
PAVIMENTAZIONE IN GOMMA RISPONDENTE A HIC RUBBER SURFACING RESPONDENT TO HIC			SOTTOPOSTA A PROVE DI CADUTA DEPENDENT ON CERTIFICATION TESTS
	SPESSORE/THICKNESS 30mm		1000
	SPESSORE/THICKNESS 40mm		1300
	SPESSORE/THICKNESS 45mm		1500
	SPESSORE/THICKNESS 60mm		2000
	SPESSORE/THICKNESS 70mm		2500
	SPESSORE/THICKNESS 90mm		3000